



art. 0180 Ø100

valvola di troppo pieno Ø100 a due sfere

two bowls overflow valve Ø100

soupape de trop plein Ø100 à deux boules

Überlaufventil Ø100 mit zwei Kugeln

válvula de llenado Ø100 con dos bolas

Aspirazione massima: 12.000 lt/min

Suction capacity: 12.000 lt/min

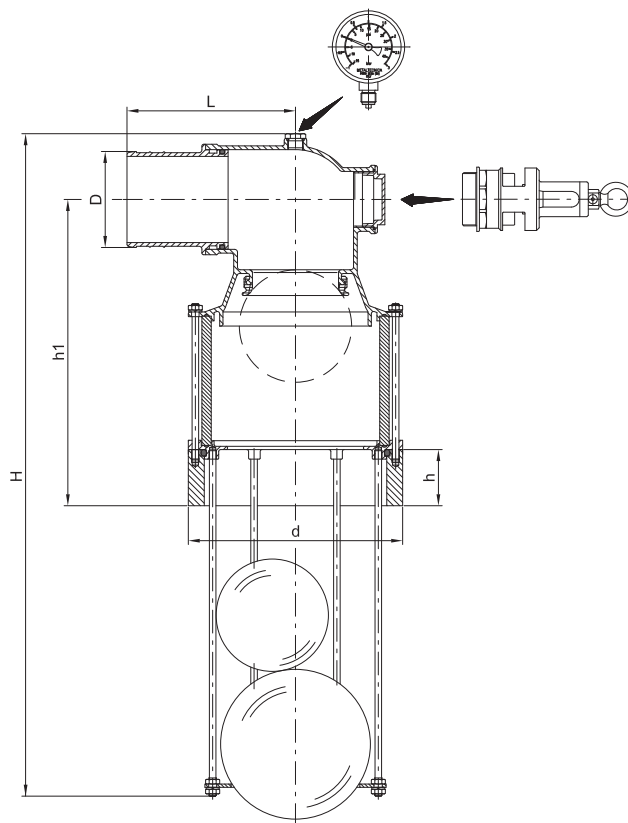

DN	100
d	229
h	60
D	102
h1	325
L	108
H	732
gr ~	16.200

Codici di ordinazione

Purchase article numbers

Valvola di troppo pieno da mm 100 a 2 sfere
Two bowls overflow valve mm 100

ARZO 0180 100 000

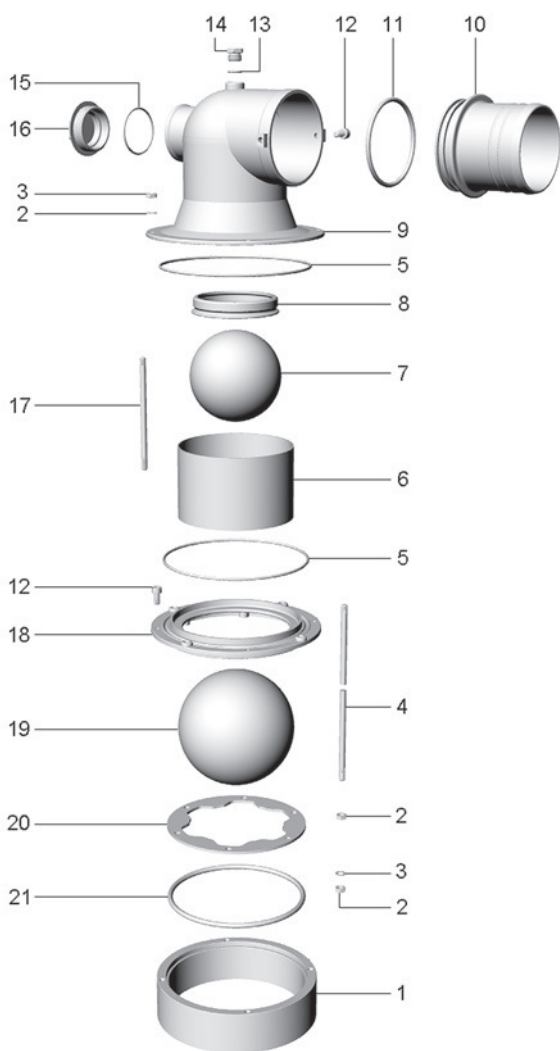

Condizioni di esercizio

Work conditions

DN	100
P(Bar)	4
P(PSI)	60
T °C	-15 +80

POS.	CODICE / CODE	DENOMINAZIONE	DENOMINATION	MATERIALE	MATERIAL
1	GHAC 0160 100 003	GHIERA Ø229×60	SCREWED RING Ø229×60	ACCIAIO	STEEL
2	DAAC 0180 045 012	DADO M8×5	NUT M8×5	ACCIAIO INOX AISI 304	AISI 304 STAINLESS STEEL
3	ROAC 0180 045 011	RONDELLA Ø14 × 8,2 × 0,8	WASHER Ø14 × 8,2 × 0,8	ACCIAIO INOX AISI 304	AISI 304 STAINLESS STEEL
4	TAZO 0160 100 018	TIRANTE M8×370	CONNECTION ROD M8×370	ACCIAIO INOX AISI 304	AISI 304 STAINLESS STEEL
5	..OR 0180 100 014	OR 4750 (Øi 190,1 × 3,53)	O RING 4750 (Øi 190,1 × 3,53)	GOMMA NBR 70	NBR 70 RUBBER
6	EPZO 0180 100 008	TUBO TRASPARENTE Ø200×136	TRASPARENT PIPE Ø200×136	METACRILATO	METACRYLATE OF METYLE
7	ARZO 0915 120 000	SFERA Ø120	BALL Ø120	ACCIAIO INOX AISI 304	AISI 304 STAINLESS STEEL
8	GGOM 0160 100 019	ANELLO A LABBRO	BRIMMED GASKET	GOMMA NBR 60	NBR 60 RUBBER
9	FOZO 0180 100 004	CORPO SUPERIORE Ø100	UPPER BODY Ø100	OTTONE UNI EN 1982	UNI EN 1982 BRASS
10	FOZO 0160 100 07D	RACCORDO DIRITTO Ø100	STRAIGHT CONNECTION Ø100	OTTONE UNI EN 1982	UNI EN 1982 BRASS
11	..OR 0020 080 003	OR 187 (Øi 94,6 × 5,34)	O RING 187 (Øi 94,6 × 5,34)	GOMMA NBR 70	NBR 70 RUBBER
12	VTAC 0020 100 009	VITE TCEI M8×16	SCREW TCEI M8×16	ACCIAIO INOX AISI 304	AISI 304 STAINLESS STEEL
13	..OR 1027 006 002	OR 117 (Øi 13,1×2,62)	O RING 117 (Øi 13,1×2,62)	GOMMA NBR 70	NBR 70 RUBBER
14	TOIR 1027 010 015	TAPPO 3/8"	COVER 3/8"	OTTONE UNI EN 12164	UNI EN 12164 BRASS
15	..OR 0180 070 017	OR 3231 (Øi 58,4×2,62)	O RING 3231 (Øi 58,4×2,62)	GOMMA NBR 70	NBR 70 RUBBER
16	SOZO 0180 070 020	TAPPO 2"	COVER 2"	OTTONE UNI EN 12165	UNI EN 12165 BRASS
17	TAZO 0180 070 018	TIRANTE M8×156	CONNECTION ROD M8×156	ACCIAIO ZINCATO	ZINC-PLATED STEEL
18	FOZO 0180 100 001	CORPO INFERIORE Ø100	LOWER BODY Ø100	OTTONE UNI EN 1982	UNI EN 1982 BRASS
19	ARZO 0920 160 000	SFERA DI SPINTA Ø160	THRUSTING BALL Ø160	ACCIAIO INOX AISI 304	AISI 304 STAINLESS STEEL
20	FOZO 0160 100 005	FLANGIA Ø194×4	FLANGE Ø194×4	OTTONE UNI EN 1982	UNI EN 1982 BRASS
21	..OR 0700 150 015	OR 233 (Øi 181,0×6,99)	O RING 233 (Øi 181,0×6,99)	GOMMA NBR 70	NBR 70 RUBBER