

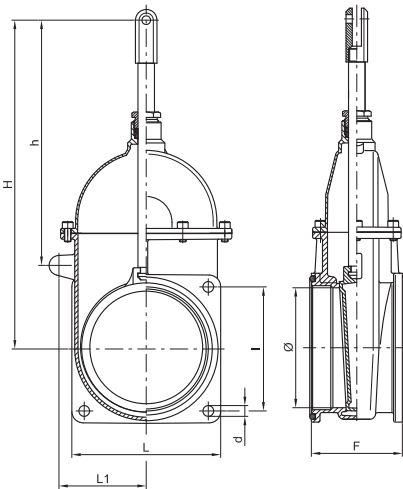

art. 0044

saracinesca a stantuffo a 2 flange*stem gate valve with 2 flanges**vanne à piston avec 2 brides**Kolbenschieber mit 2 Flanschen**tajadera c/ pistón con doble brida*

Ø"	Codice / Code	Ø	h	H	L1	L	d	l	F	📦 gr
4"	ARZO 0044 100 000	95	234	308	96	180	13	150	100	6.800
6"	ARZO 0044 150 000	145	286	390	105,5	180	13	150	110	10.100

Senza asta / Without stem

Ø"	Codice / Code	📦 gr
4"	ARZO 0044 100 SMO	6.050
6"	ARZO 0044 150 SMO	9.200



Con cilindro art. 0500 / With cylinder item 0500

Ø"	Codice / Code	h	H	📦 gr
4"	ARZO 0044 100 500	239	673	9.640
6"	ARZO 0044 150 500	318	752	12.860



Con cilindro art. 0510 / With cylinder item 0510

Ø"	Codice / Code	h	H	📦 gr
4"	ARZO 0044 100 510	239	627	12.730
6"	ARZO 0044 150 510	318	706	16.020



Con cilindro art. 0550 / With cylinder item 0550

Ø"	Codice / Code	h	H	📦 gr
4"	ARZO 0044 100 550	239	489	8.210
6"	ARZO 0044 150 550	318	568	11.360

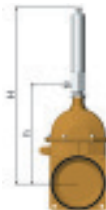

Con cilindro art. 0570 / With cylinder item 0570

Ø"	Codice / Code	h	H	📦 gr
4"	ARZO 0044 100 570	242	440	9.020
6"	ARZO 0044 150 570	321	570	12.490

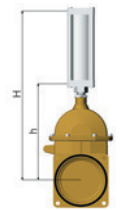

Con cilindro art. 0571 / With cylinder item 0571

Ø"	Codice / Code	h	H	📦 gr
4"	ARZO 0044 100 571	242	440	9.050
6"	ARZO 0044 150 571	321	570	12.520



Con cilindro art. 0580 / With cylinder item 0580

Ø"	Codice / Code	h	H	📦 gr
4"	ARZO 0044 100 580	241	529	13.850
6"	ARZO 0044 150 580	320	723	18.970

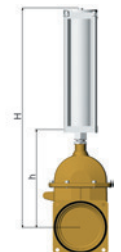

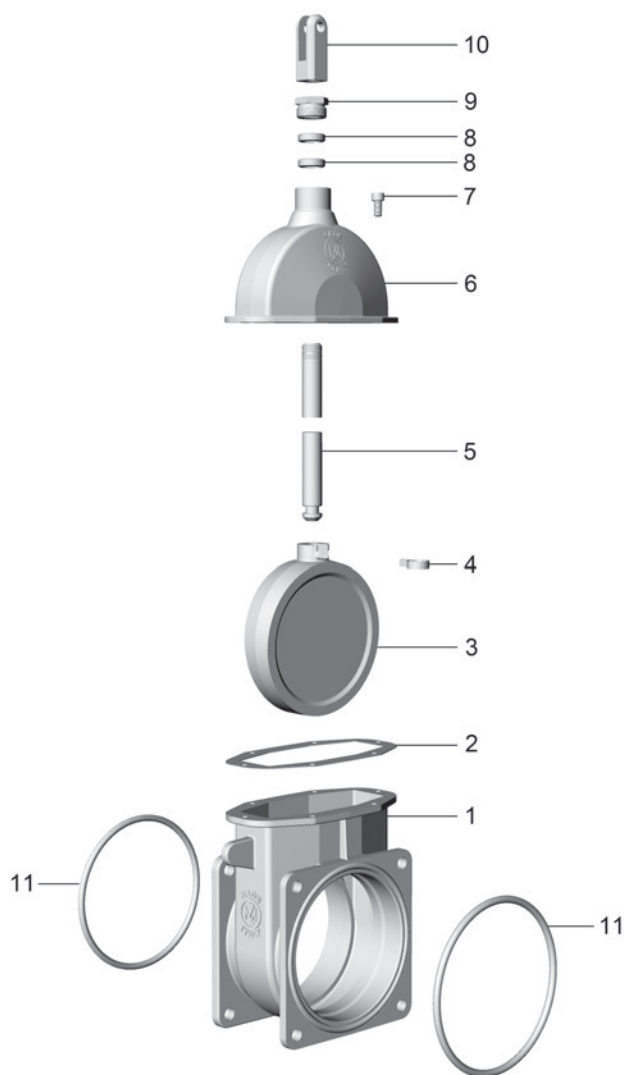

Condizioni di esercizio

Work conditions

DN	4" - 6"
P(Bar)	4
P(PSI)	60
T °C	-15 +80

POS.	CODICE / CODE	DENOMINAZIONE	DENOMINATION	MATERIALE	MATERIAL
1	FOZO 0044 100 001	CORPO 4"	BODY 4"	OTTONE UNI EN 1982	UNI EN 1982 BRASS
1	FOZO 0044 150 001	CORPO 6"	BODY 6"	OTTONE UNI EN 1982	UNI EN 1982 BRASS
2	GGUA 0040 100 004	GUARNIZIONE 4"	GASKET 4"	GUAMOTOR	GUAMOTOR
2	GGUA 0040 150 004	GUARNIZIONE 6"	GASKET 6"	GUAMOTOR	GUAMOTOR
3	FOZO 0040 100 002	CUNEO 4"	GATE 4"	OTTONE UNI EN 12165	UNI EN 12165 BRASS
3	FOZO 0040 150 002	CUNEO 6"	GATE 6"	OTTONE UNI EN 1982	UNI EN 1982 BRASS
4	SAZO 0040 100 011	FASCETTA DI BLOCCAGGIO Ø20	LOCKING CLAMP Ø20	ACCIAIO INOX AISI 304	AISI 304 STAINLESS STEEL
5	TOZO 0040 100 003	ASTA 4"	STEM 4"	OTTONE UNI EN 12164	UNI EN 12164 BRASS
5	TOZO 0040 150 003	ASTA 6"	STEM 6"	OTTONE UNI EN 12164	UNI EN 12164 BRASS
6	FOZO 0040 100 005	TESTATA 4"	HEAD 4"	OTTONE UNI EN 1982	UNI EN 1982 BRASS
6	FOZO 0040 150 005	TESTATA 6"	HEAD 6"	OTTONE UNI EN 1982	UNI EN 1982 BRASS
7	VTAC 0020 100 009	VITE TCEI M8×16	SCREW TCEI M8×16	ACCIAIO INOX AISI 304	AISI 304 STAINLESS STEEL
8	SPZO 0040 100 006	GUARNIZIONE Ø27 × 20 × 8	GASKET Ø27 × 20 × 8	POLIMERO	POLYMER
9	TOZO 0040 100 007	PREMISTOPPA M30×2	NUT M30×2	OTTONE UNI EN 12164	UNI EN 12164 BRASS
10	FOZO 0040 100 008	FORCELLA	FORK	OTTONE UNI EN 1982	UNI EN 1982 BRASS
11	..OR 0020 100 010	OR 225 (Øi 159,5 × 6,99)	O RING 225 (Øi 159,5 × 6,99)	GOMMA NBR 70	NBR 70 RUBBER